

**Technology for a successful
Koi- and fish pond!**



	Page
Pond filters	2-6
Pond pumps	7-9
Pond UVC	10-11
Air pumps	12-13
Protection	14
Koi accessories	15
Pond accessories	16

Make your pond hobby a succes together with SuperFish. For over 25 years we have grown and sold Koi and pond fish. From this experience, we develop pond products and pond care products that offer the best for your precious Koi and pond fish.

Our goal:
To make your fish- and Koi hobby successful and affordable.

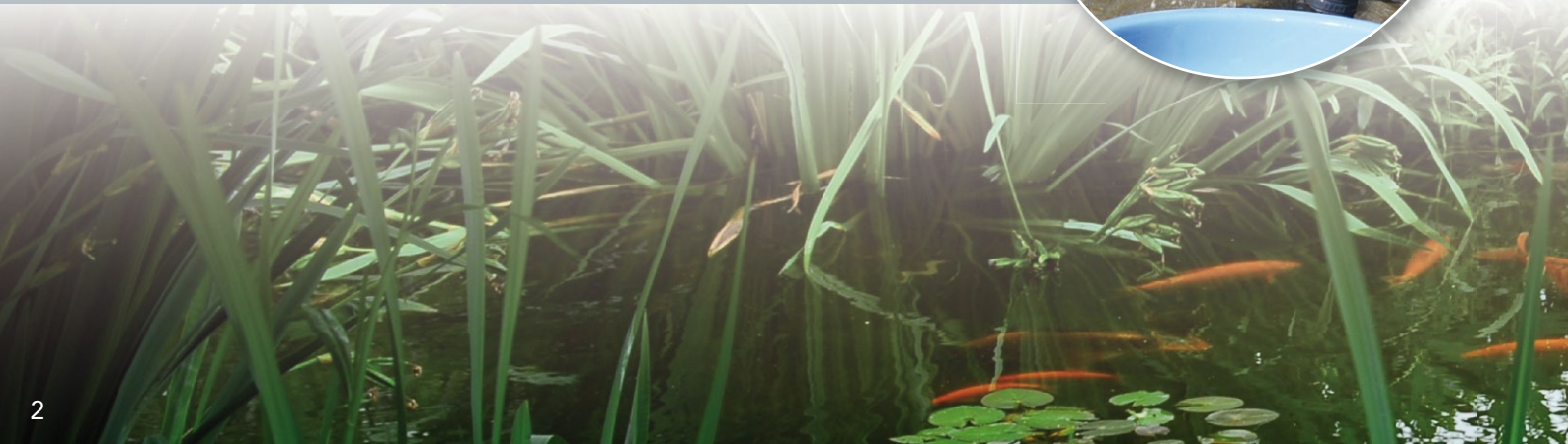

The correct filter for a clean and healthy pond

An appropriate filter ensures healthy and clean water in the pond. The filter will filtrate and transforms waste. The filtration takes place in the mechanical part of the filter, here the coarser dirt particles are filtered out. In the biological filter section, the harmful substances are converted by bacteria into plant food.

Filters are available in many sizes and different types. Which filter is most suitable depends on the situation.

The following factors determine which filter is most suitable:

- The amount of fish in the pond determines the size of the filter. The more fish in the pond are kept, the more waste is produced, so the larger the filter should be.
- When the pond is situated in a sunny area or it's a shallow pond, than also a bigger filter is needed.
- The content of the pond, a large pond requires a different filter than a small pond.
- Is the pond a Koi- or fishpond, a botanical pond or a combination pond of fish and plants. Plants will help to keep your pond in balance, they can help to break down waste in the pond.
- A pond filter and pump must be in operation 24 hours a day, if possible 12 months per year. Only in danger of freezing turn the pump and filter off and clean it immediately.



SuperFish Pond Clear Kit

Basic biological pond filters for smaller ponds. Complete with built-in UVC, for a clear pond within a fortnight, and an energy-efficient Pond-Flow ECO pond pump.

- Including biological pond filter media.
- Built-in UVC.
- Including Pond-Flow Eco-energy pond pump.

Technical specifications

Art.	Model	Max pond content	Pump cap.	UVC	Inlet	Outlet	Size
E6020301	Pond Clear Kit 2500	2,500 L	1,000 L/h	5 Watt	12/20/25 mm	32 mm	35x30 cm
E6020310	Pond Clear Kit 5000	5,000 L	2,000 L/h	9 Watt	12/20/25 mm	32 mm	ø40x33 cm
E6020313	Pond Clear Kit 7500	7,500 L	3,000 L/h	11 Watt	25 mm	32 mm	ø40x38 cm



SuperFish TopClear

Unique 3-step pond pressure filter.

- 1: Filter foam provides the mechanical filtering.
- 2: Bacteria in the Bio-Balls provide the biological purification.
- 3: Built-in UVC provides control of algae and works to prevent against diseases.

- All connections are on top of the lid. So the filter can be placed everywhere, invisible, beside, under or near the pond.
- A pressure filter can be placed even below the water level.
- Auto Clean Wash: backwash system for simple filter cleaning (just let the dirty water drain away).
- 2-year warranty.

TopClear Kit

All TopClear filters are also available with a matching Pond-Flow pump as a complete 3-in-1 kit.



Built-in UVC, clarifies your pond water within a fortnight.



Auto Clean Wash, backwash system for easy cleaning.



The TopClear filter can be placed almost anywhere, even below the water level.



Technical specifications

Art.	Model	Max pond content	Pump cap.	UVC	Inlet	Outlet	Size.
E6020130	TopClear 5000	5,000 L	2,500 L/h	7 Watt	12/25/32 mm	12/25/32 mm	34x34x40 cm
E6020135	TopClear 10000	10,000 L	3,500 L/h	9 Watt	12/25/32 mm	12/25/32 mm	35x44x46 cm
E6020140	TopClear 15000	15,000 L	5,000 L/h	11 Watt	25/32/40 mm	25/32/40 mm	35x44x58 cm
E6020145	TopClear Kit 5000	5,000 L	2,000 L/h	7 Watt	12/25/32 mm	12/25/32 mm	34x34x40 cm
E6020150	TopClear Kit 10000	10,000 L	2,900 L/h	9 Watt	12/25/32 mm	12/25/32 mm	35x44x46 cm
E6020155	TopClear Kit 15000	15,000 L	5,000 L/h	11 Watt	25/32/40 mm	25/32/40 mm	35x44x58 cm





SuperFish FlowClear 10000

The ideal filter for fish and Koi ponds up to approximately 10,000 litres.

- The filter media, consisting of three sets of Matala mats with different meshes and a very open structure, prevents clogging and assures optimal bacteria growth and outstanding filtration. A cartridge filled with zeolite, a porous material that absorbs ammonia and harmful substances, helps keep your pond healthy.
- Easy cleaning, the clever filter structure lets coarse dirt sink to the bottom of the filter, where a gate valve allows the dirt to drain for easy cleaning.
- Built-in UVC with PHILIPS lamp combats the growth of green algae and clarifies your pond water within 14 days. PHILIPS guarantees an operating life of 8,000 hours for the lamp and we provide a 2-year warranty on the electrical components of the UV-C unit.
- Also available as a complete FlowClear Kit including a PondEco 5000 pond pump.

FallClear 10000

Identical filter as the FlowClear, but with a built-in decorative waterfall. This adds extra oxygen to the pond water.



1 2 3 4 5 6 7 8 9 10 11 12 13 14
Clears your pond within a fortnight

SuperFish FlowClear 20000

Biological 3-chamber filter, guarantees the quality of your water and ensures a good biological balance in your pond.

- Filters and disinfects your pond water at the same time, ensuring quick results and the optimal purification of the water.
- The UV-C radiation ensures that bacteria, germs and floating algae have no chance to develop, thereby guaranteeing the clarity of your pond water.



Technical specifications

Art.	Model	Max pond content	Pump cap.	UVC	Inlet	Outlet	Size
E6030010	FlowClear 10000	10,000 L	5,000 L/h	11 Watt	25/32/40 mm	40 mm	55x36x45 cm
E6030013	FlowClear Kit 10000	10,000 L	4,800 L/h	11 Watt	25/32/40 mm	40 mm	55x36x45 cm
E6030065	FallClear 10000	10,000 L	5,000 L/h	11 Watt	25/32/40 mm	waterfall	55x36x45 cm
E6030085	FlowClear 20000	20,000 L	10,000 L/h	40 Watt	32 mm	63 mm	100x43x65 cm



Optimize the performance of your pond filter

SuperFish CrystalMax maximizes biological filtration.
SuperFish Norit® Activated Carbon absorbs harmful substances.
SuperFish Crystal Clear removes ammonia and nitrates from the pond water.

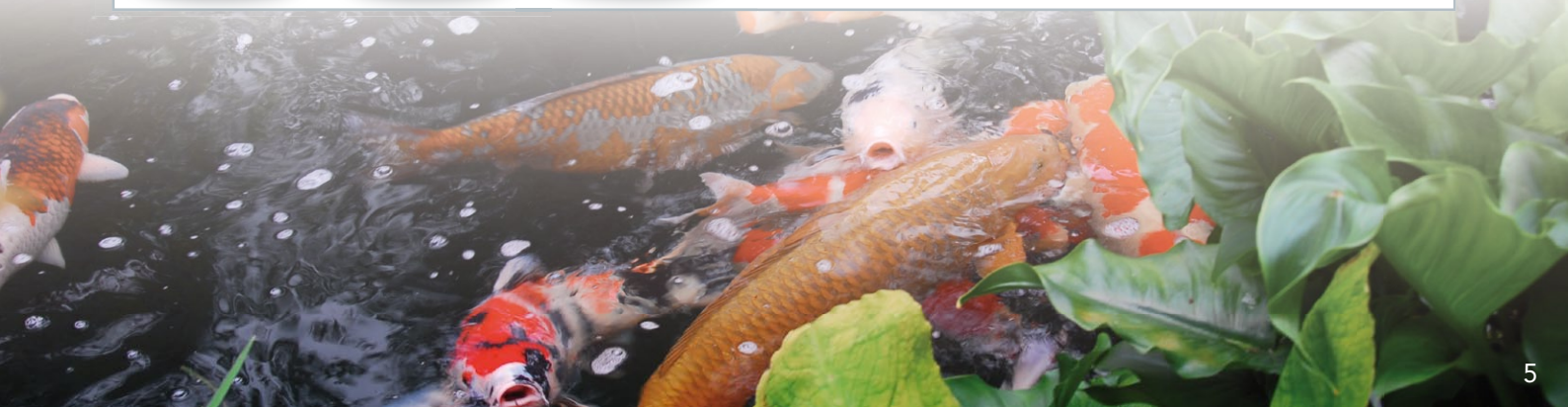

Pond filters

SuperFish Poly Tech Move

SuperFish Poly Tech Move

Polytech Move filters are specially designed for Koi and fish ponds and large water features. A Polytech Move filter offers the advantages of a multiple chamber filter, that is a reliable technique and stability by a large biomass, combined with a so-called floating bed filter, which ensures an extremely good biological filtration.

SuperFish Polytech Move filter advantages:

- Excellent dirt separation by the filter brushes in the first filter chamber.
- Optimum water flow through Japanese mats.
- Outstanding ventilation by the filter chamber with the "floating bed" filter media.
- Easy to clean; the "floating bed" media is self-cleaning.

Extremely high biological action by Floating Bed Filtration

Floating Bed Filtration is developed in the aquaculture. It consists of knurled plastic rings which are floating in the water, with a very high adhesion surface. These are kept continuously in motion by means of aeration. The aeration comes from the bottom, so the filter medium is churned up over and over again. Bacterial Cultures will develop very well and after approximately 2 months, the white rings are therefore brown colored by the bacteria. The system is virtually maintenance free and the biological effect is extremely good.

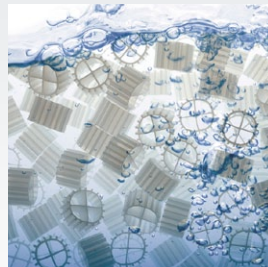
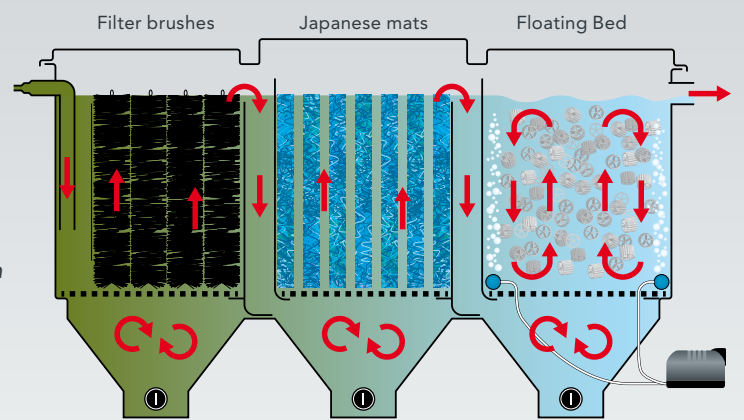

Air pump

An air pump is necessary for the floating bed filtration. We recommend the Superfish Koi-Flow. (see page 13)

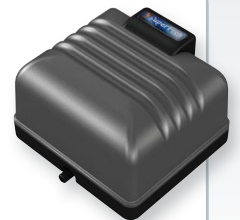

Technical specifications

Art.	Model	Max content Natural pond	Max content Combi-pond	Max content Koi pond	Max pump cap.	Chambers	Inlet	Outlet	Size
06040500	Move 20	20,000 L	15,000 L	10,000 L	2,000 L/h	2	25/32/40 mm	75 mm	80x65x65 cm
06040505	Move 30	30,000 L	22,500 L	17,500 L	3,000 L/h	3	25/32/40 mm	75 mm	120x65x65 cm
06040510	Move 60	60,000 L	45,000 L	30,000 L	9,000 L/h	3	50/100 mm	75 mm	150x80x75 cm
06040515	Move 100	100,000 L	75,000 L	50,000 L	15,000 L/h	3	50/100 mm	110 mm	185x95x90 cm
06040520	Move 200	200,000 L	150,000 L	100,000 L	25,000 L/h	3	50/100 mm	110 mm	225x108x100 cm

The Move 20 and 30 are pump fed, the Move 60, 100 and 200 can also be use as a gravity-filter with the supplied coupling piece.

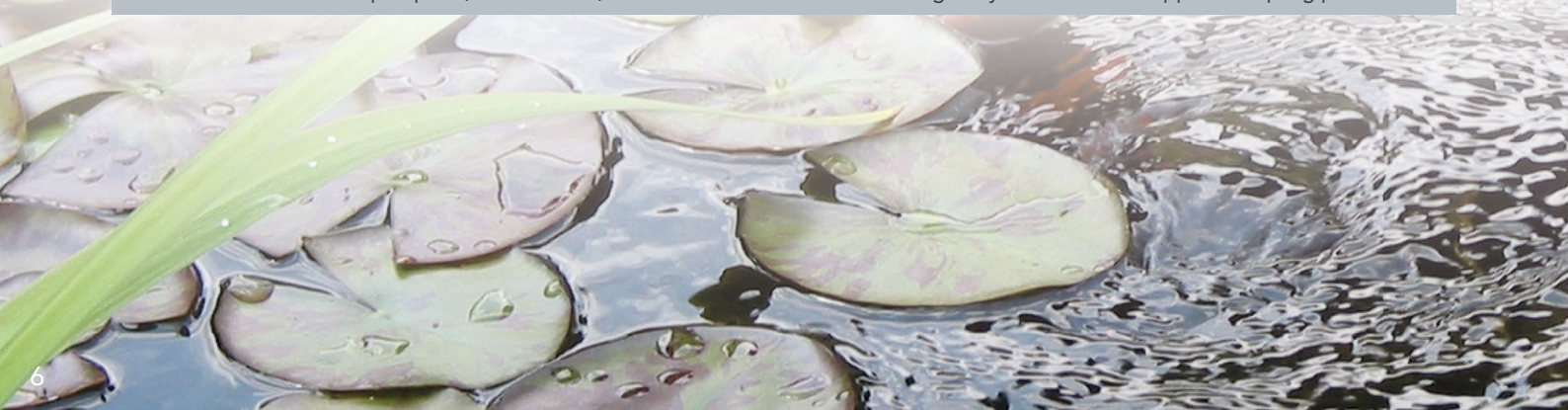

The pump is the heart of the pond!

Just as important as a good filter is a good pump. The pond pump is there to ensure that the contaminated water ends up in the filter.

This you should consider when purchasing a right pump:

- The pump capacity should be 50% of the pond volume for a thorough cleaning.
- Consider capacity losses due to hose length, UV lamp and head.
- For proper cleaning, it is better to use a pump without a pre-filter. So the dirt particles get into your filter instead of into the pre-filter.
- To maximize the sucking of dirt, place the pump in the deepest part of the pond.
- For proper circulation, place the pump and filter outlet as far apart as possible.
- If you want a fountain or a water bubble, buy a separate pump with a pre-filter. These small pumps are very affordable and your fountain doesn't have to spray all day.

SuperFish Pond-Flow ECO

Multipurpose pond pump for fountain and simple pond filters.

- Available in 3 types with different pump capacities (1,000 L/h, 2,000 L/h and 2,900 L/h).
- Including 2 different spray heads: a fountain nozzle and a mushroom nozzle which are easily adjustable in height.
- Energy efficient, so economical to run.
- Complete with 10-metre power cable and a 2-year warranty.



Technical specifications

Art.	Model	Max pump cap.	H.max	Outlet	Power
E7060015	Pond-Flow ECO 1000	1,000 L/h	1.4 m	20/25/30 mm	12 Watt
E7060020	Pond-Flow ECO 2000	2,000 L/h	1.9 m	20/25/30 mm	25 Watt
E7060025	Pond-Flow ECO 3000	2,900 L/h	2.3 m	20/25/30 mm	45 Watt

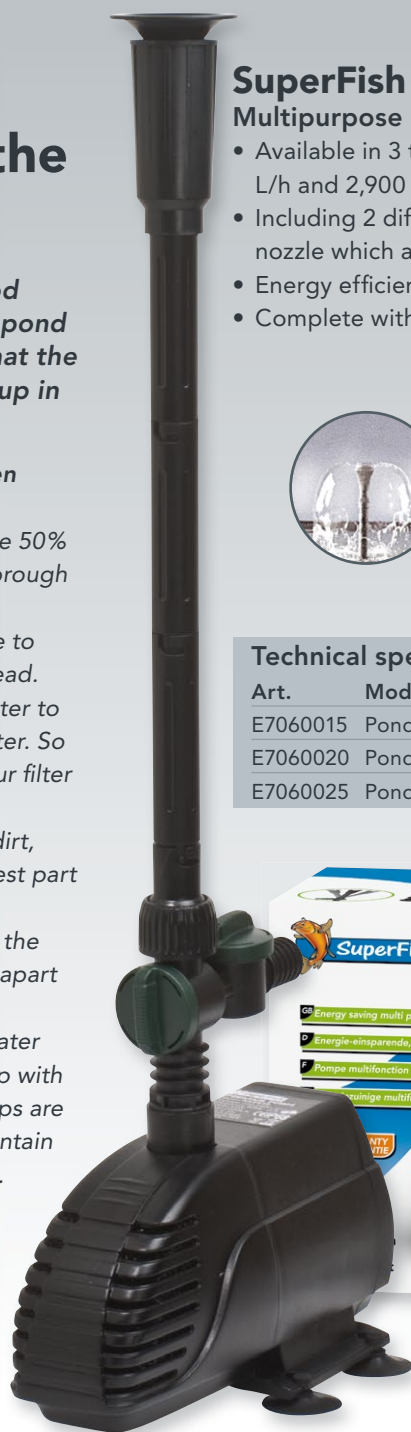

SuperFish Pump Clean

Periodic cleaning of your pond pump is necessary to prolong its service life and maintain the warranty. Your pump accumulates lime deposits while it is in the pond, which cause algae and dirt to adhere to the pump. Pump Clean is a natural acid that dissolves lime deposits and cleans your pump.

[Art. 07070500]



Save up to 50% on purchase price and power costs compared to other pumps!

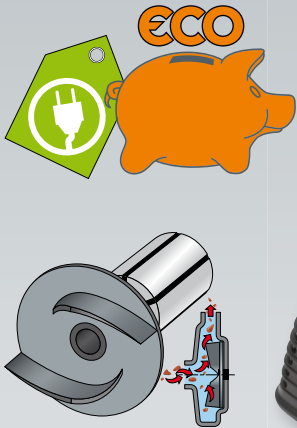

SuperFish PondECO

Specially designed synchronous pump with high capacity and very low power consumption. Combined with an economical price, this makes the PondECO a perfect pond pump for all kinds of ponds. Quality for an affordable price!

- 3-year warranty and GS approval for quality and safety.
- Pumps large quantities of water with low electricity consumption.
- DCS: ceramic drive and gear wheels for minimum wear.
- Vortex blades transport coarse dirt particles up to 8 mm.
- Rotating Multi-step hose connection.
- Easy to install and virtually maintenance-free.

Technical specifications

Art.	Model	Max pump cap.	H.max	Outlet	Power
E7070145	PondECO 3500	3,600 L/h	2.4 m	25/32/40 mm	45 Watt
E7070150	PondECO 5000	4,800 L/h	2.5 m	25/32/40 mm	60 Watt
E7070155	PondECO 8000	7,200 L/h	4.0 m	25/32/40 mm	80 Watt
E7070160	PondECO 12000	11,300 L/h	4.5 m	25/32/40 mm	155 Watt
E7070165	PondECO 15000	14,200 L/h	4.1 m	25/32/40 mm	175 Watt



SuperFish Pond Skim

The Super Fish pond skimmer floats in the pond and sucks dirt, such as leaves, dust and algae from the water surface. It's easy to clean thanks to the removable waste grid. For a clean and healthy pond.

Technical specifications

Art.	Model	Pump cap.	Pond size	Power
E7060050	Pond Skim 2000	2,000 L/h	25 m ²	25 Watt
E7060060	Pond Skim 3000	3,000 L/h	40 m ²	40 Watt



Demo



3-year on-site 48-hour "Pick-up & Replace" service!

*If your pump is broken, it's a major problem for costly pond and fish. But no need to worry, within 48 hours we will deliver a new pump without charge.**

**From Monday to Friday, on Saturday and Sunday no deliveries.*



SuperFish PondECO Plus

Professional filter pump for Koi and fish ponds with unique Pick-up and Replace service and the lowest possible energy consumption (approx. 12 watts per 1.000 L/h). A pond pump that truly deserves a "green label"!

- Easy to install.
- Two outlet options (on top or on side) with a rotating Multi-step hose connection.
- Vortex blades and DCS drive and gear.
- 3-year warranty and GS approval.

Technical specifications

Art.	Model	Max pump cap.	H.max	Outlet	Power
E7070180	PondECO Plus 8000	7,150 L/h	2.5 m	25/32/40/50 mm	72 Watt
E7070185	PondECO Plus 12000	10,850 L/h	3.4 m	25/32/40/50 mm	135 Watt
E7070190	PondECO Plus 15000	14,800 L/h	4.5 m	25/32/40/50 mm	157 Watt
E7070195	PondECO Plus 20000	18,500 L/h	5.5 m	25/32/40/50 mm	220 Watt

SuperFish HighFlow

Professional high flow water pump for large ponds and aqua culture. Also for water movement in large Koi ponds and water features.

- Energy efficient, moves large volumes of water with a low power consumption.
- DCS ceramic drive and gear wheels and Vortex blades.
- 110 mm outlet for maximum flow.



Technical specifications

Art.	Model	Max pump cap.	H.max	Outlet	Power
E7070550	HighFlow 20000	20,000 L/h	2,8 m	110 mm	158 Watt
E7070555	HighFlow 30000	30,000 L/h	4,0 m	110 mm	235 Watt
E7070560	HighFlow 50000	45,000 L/h	5,5 m	110 mm	398 Watt



An UVC provides crystal clear water!

Even though the water in your pond has the perfect composition and you have a good filter, you can still suffer from algae.

There are several reasons for this:

- A new filter or a new pond needs time to come into balance. In the meantime, algae can arise.
- When starting up the pond in the spring, after a (too) thorough cleaning of the filter and at high temperatures, the biological balance becomes disturbed and algae will thrive.
- If plants can't keep up with the production of nutrients by the fish and filter, which is often the case with Koi ponds, floating algae see their opportunity to grow.

Your pond becomes green and cloudy. These floating algae are too small to be filtered. Therefore, you must install a UVC. The pond pump feeds the pond water through the UVC unit, where it flows past a special lamp. The UV-C radiation produced by this lamp kills harmful bacteria and germs and keeps algae growth under control.



SuperFish Reflex UVC

SuperFish Reflex UVC, suitable for small to medium ponds.

- Philips PL-lamp, guaranteed for 8000 operating hours.
- Stainless steel interior.
- Multi-step hose connection.

1 2 3 4 5 6 7 8 9 10 11 12 13 14

Clears your pond within a fortnight



SuperFish ALU Tech UVC

SuperFish ALU UVC, suitable for big combi-ponds.

- T5 High Output UV lamp for optimum clarification.
- Guaranteed 8000 operating hours.
- Double Head Connection, enabling you to install the UV-C device any way you like.
- Aluminium housing, reflects the UV-C radiation.

Technische specificaties

Art.	Model	Max pond content	Max pump cap.	In-/Outlet	Lamp	Power	Reflection
E6010055	Reflex UVC 7000 / 9 W	7,000 L	5,000 L/h	20/25/32 mm	Philips PL	9 Watt	Yes
E6010060	Reflex UVC 10000 / 11 W	10,000 L	7,500 L/h	20/25/32 mm	Philips PL	11 Watt	Yes
E6010120	ALU Tech UVC 40 W	40,000 L	20,000 L/h	25/32/40 mm	High Power T5	40 Watt	Alu
E6010125	ALU Tech UVC 75 W	75,000 L	20,000 L/h	25/32/40 mm	High Power T5	75 Watt	Alu



SuperFish UVC Tech

Professional UVC suitable for (big) Koi ponds up to 75,000 litres.

- High Output T5 UV-lamp, guaranteed for 8000 operating hours.
- Electrolytically polished stainless steel housing, preventing dirt to attach and ensuring the optimal reflection of UV-C.

SuperFish UVC Master

The UVC Master combines all characteristics and benefits of the UVC Tech with a dosage pump for bacteria and a timer.

- Integrated computer controlled timer for effective use of the UV-C lamp and dosage pump.
- Full automatically and tailor made bacteria dosing.
- Easy to use and reducing energy consumption.



Koi Pro UVC

Professional highest quality UVC-unit

- Durable stainless steel, electrolytically polished.
- High Output T5 UV-lamp.
- The electronic ballast ensures optimal light yield and increases the operating life of the lamp.
- Longer exposure to higher doses of UV-C through the length of the device.
- Both PVC connection and Multi-step hose connection.

SuperFish UVC Clean

Clean your UVC unit and the quartz glass tube with SuperFish UVC Clean. This Cleaner is specially developed for this purpose. You should replace the UV lamp in your UVC unit every year for proper function. [Art. 06010100]



Technical specifications

Art.	Model	Max pond content	Max pump cap.	In-/Outlet	Lamp	Power	Reflection
E6010075	UV-C Tech 40W	40,000 L	20,000 L/h	25/32/40 mm	High Power T5	40 Watt	stainl. steel
E6010080	UV-C Tech 75W	75,000 L	20,000 L/h	25/32/40 mm	High Power T5	75 Watt	stainl. steel
E6010210	UVC Master 75000 T5 75W	75,000 L	20,000 L/h	25/32/40 mm	High Power T5	75 Watt	stainl. steel
E6010200	KoiPro RVS UVC T5 40W	40,000 L	20,000 L/h	50/63 mm	High Power T5	40 Watt	stainl. steel
E6010205	KoiPro RVS UVC T5 75W	75,000 L	20,000 L/h	50/63 mm	High Power T5	75 Watt	stainl. steel

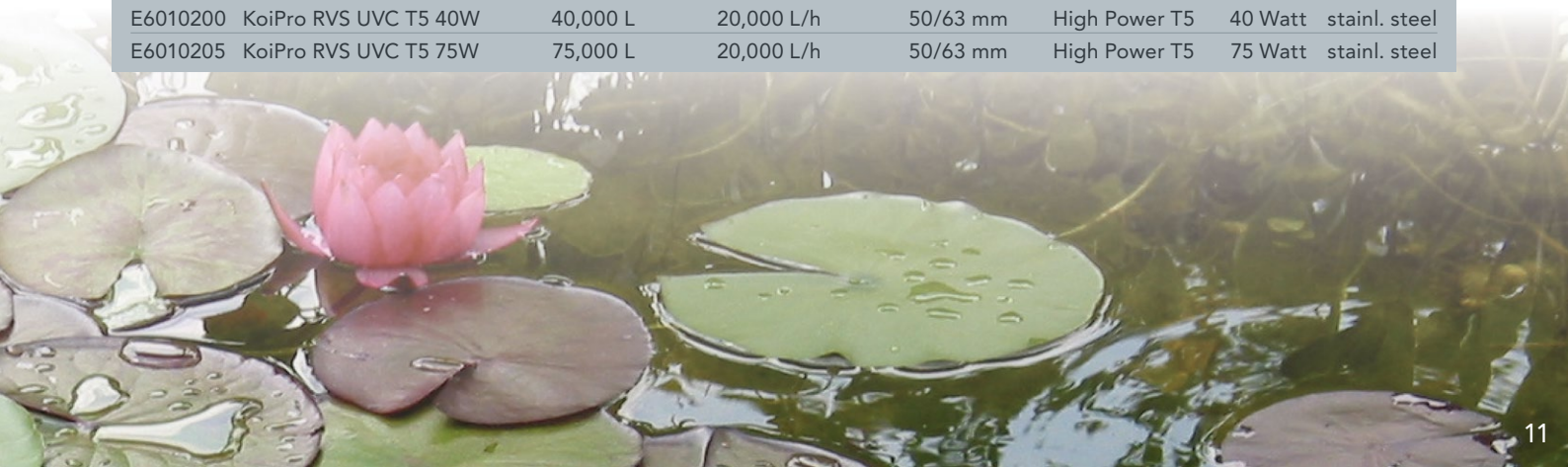

Air pumps

SuperFish Air-Kit & Air-Box

Oxygen, essential for a healthy pond

Oxygen is essential for all life in the pond. Plants, bacteria and especially your fish require enough oxygen. An air pump is therefore recommended.

In the summer an air pump provides the need for oxygen of your pond and in the winter it keeps an existing ice hole open.

When the oxygen in your filter is insufficient, your filter will work insufficient. Therefore place an air-stone in your filter to insure a proper function of the filter. And in case your pump stops unexpectedly, the bacteria in your filter will stay alive by aeration and movement of water. Which air pump is appropriate depends on the size of the pond.



SuperFish Air-Box

Complete aeration kits supplied in a handy box for protection against rain and splashed water.

- Provides fresh oxygen in the water.
- Keeps your pond healthy in the summer and ice-free in the winter.
- Supplied complete with air hose and 1, 2 or 4 air stones (depending on the type).



SuperFish Air-Kit

Complete aeration kits for ponds.

- These kits are complete with air hose and 1 or 2 air stones (depending on the type).
- Spare membrane for long lasting usage.
- The Air-Kit Mini is ideal as an additional air pump for the filter.

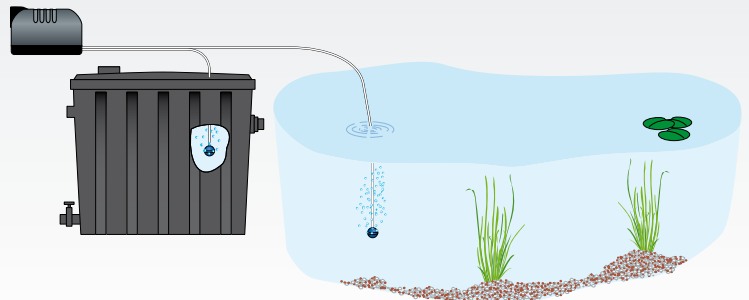

Technical specifications

Art	Model	Air output	Pressure	Power
E7010309	Air-Kit mini	78 L/h	0.015 MPA	1,5 Watt
E7010310	Air-Kit 1	96 L/h	0.015 MPA	2 Watt
E7010315	Air-Kit 2	240 L/h	0.020 MPA	4 Watt
E7010325	Air-Box 1	96 L/h	0.015 MPA	2 Watt
E7010330	Air-Box 2	240 L/h	0.020 MPA	4 Watt
E7010335	Air-Box 4	600 L/h	0.012 MPA	10 Watt



Extra oxygen

Especially for Koi ponds and large ponds we developed these air pumps. The pumps have a high air flow performance and long life. If necessary wearing part can be replaced for years of enjoyment.

SuperFish Koi-Flow

Pond air pump for larger ponds and Koi ponds.

- High air output at low power.
- Low noise and long life.
- Complete with 6 air stones and an air hose of 50 metres.
- Including spare membranes.



SuperFish AirBlow

Professional pond air pumps, specially developed for high air output even at depths up to 3 metres. Suited for Koi ponds and large ponds, but also for breeding, sale and quarantine systems, where many outflow points are needed.

- High air output.
- High air pressure.
- Suitable for many air outflow points.
- Including spare membranes.
- 2-year full warranty.



SuperFish air stones

Air Stones are available in 2 types. The blue SuperFish air stones come in many different sizes and shapes and are suitable for all use. Airstones gradually become clogged in the course of time due to dirt and deposits, therefore replace the air stones every year. The grey Hi-Oxygen air stones are specially treated at very high temperatures, therefore these stones are long lasting and produce very fine air bubbles.

Technical specifications

Art	Model	Air output	Pressure	Power
E7010430	Koi-Flow 20	1,200 L/h	0.025 MPA	15 Watt
E7010435	Koi-Flow 30	1,800 L/h	0.025 MPA	25 Watt
E7010440	Koi-Flow 60	3,600 L/h	0.025 MPA	35 Watt
E7020300	Air-Blow 50	3,000 L/h	0.045 MPA	30 Watt
E7020305	Air-Blow 100	6,000 L/h	0.040 MPA	88 Watt

Protect your fish

SuperFish Bird & Cat Scare

Sprinkler with motion sensor, the most effective and humane way to protect your fish against herons, cats, and other intruders.

Simply connect the Bird & Cat Scare to a hose, and whenever it senses an intruder it chases the intruder away with a powerful spray of water. The Bird & Cat Scare has adjustable range and sensitivity and is suitable for both large and small ponds.

[Art. E6090150]

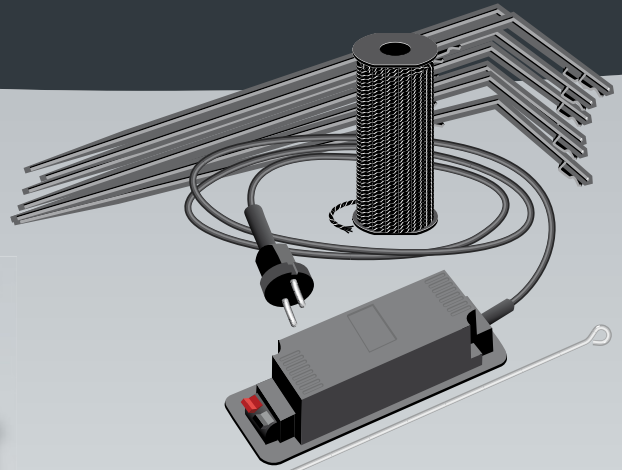

Pond Defence

Electric fence wire (100 or 500 m) for ponds, protects your fish against herons and cats. Enough to protect 50 or 250 metres of pond perimeter with a double electric fence wire.

- Easy to install.
- Additional pegs (10 pieces) available.

[Art. E6070001 Pond Defence 100 M]

[Art. E6070003 Pond Defence 500 M]

SuperFish Pond cover net

A Pond cover net prevents leaves and any other debris from blowing into the pond and protects your fish against herons and cats.

Place the pond cover net in time, as dirt has a negative impact on the water quality and dirt is hard to remove once it is inside the pond.

- Includes ground pins.
- Easy to place.
- Fine and flexible mesh.
- Strong synthetic fibres.
- Long lasting.

[Art. 06090699 3x2 m]

[Art. 06090700 4x3 m]

[Art. 06090705 4x4 m]

[Art. 06090710 5x4 m]

[Art. 06090715 6x4 m]

[Art. 06090718 10x6 m]



SuperFish Pond Alarm

Herons, cats, other animals and even thieves lurking on your precious fish.

It is therefore recommended to protect your fish adequately against intruders. An unwanted visitor will be chased away by the powerful signal of the Pond Alarm when approaching the pond.

[Art. E6070010]



Automatic feeders

Feeding your fish with an automatic feeder has many advantages. You get the most out of your fish by always precisely providing the correct amount of feed. This ensures optimal growth and a prettier colour pattern, for example in Koi.

As the food is dosed in smaller amounts at a time, this has a beneficial effect on the health of the fish, and on your pond.

Koi nets

Aluminium Koi nets are strong light-weight and non-rusting.

The round koi nets are specifically intended for koi, and the edge of the net is fitted in the hoop to prevent wear. The handles and nets are sold separately so you can use different nets with the same handle.

[Art. 09050224 Net round Ø 60 cm]

[Art. 09050234 Net round Ø 70 cm]

[Art. 09050239 Net round Ø 80 cm]

[Art. 09050224 Net square 58x38 cm]

[Art. 09050494 Handle 200 cm]

[Art. 09050496 Handle 250 cm]

[Art. 09050497 Handle 300 cm]



SuperFish Koifeeder

Automatic feeder, can be placed on the edge of the pond or quarantine tank and the unique brush dispenser will shoot the food into the pond.

- 1 to 4 feeding times per day.
- Food amount is adjustable from 50 to 1400 gram per day.
- Battery operated.
- Suitable for pellets.
- Food capacity up to 10 litre.

[Art. E6090195]



Professional feeder

With the Professional Feeder you can automatically feed your Koi several times per day.

- Automatic feeding between 1 and 24 times a day.
- Quantity of feed can be set per dosing.
- Suitable for pellets (size 2-9 mm).
- Mounting bracket included.
- 10 metre power cable.
- Food container for 7 litres of food.

[Art. E6090199]

Koi bowls

Handy bowls in various sizes for temporarily holding, showing, treating, or transporting of your fish.

[Art. 06090699 Bowl Ø 50 cm]

[Art. 06090700 Bowl Ø 67 cm]

[Art. 06090705 Bowl Ø 80 cm]



Spawning Brushes

Would you like to breed your own koi? All you need is a male and at least two female koi, plus a roomy pond. Put the spawn brushes in the pond so they can float, and then let nature take its course. The breeding season of koi is from April to June.

[Art. 08060660]



Take care of your fish all year round!

SuperFish has several accessories that make maintaining and taking care of your fish and pond easy. These tools help you to enjoy your pond all year round.



SuperFish Pond Thermometer

How often you have to feed your fish, and how much food you should give them, depends on the temperature of the pond water.

For proper care, it is thus important to know the temperature of the pond water. With a SuperFish pond thermometer you can easily and precisely measure the water temperature.

[Art. 06090005 Pond Thermometer]

[Art. A6090015 Solar Pond Thermometer]



SuperFish FlexiPower

This garden power socket provides a safe, convenient source of electrical power outdoors wherever you need it.

- Suitable for use at the pond, garden tools, garden lighting, at the campground and for countless other purposes.
- 10 meter cable length.
- 4 sockets, earthed.

[Art. E6070005]

SuperFish Pond Vac

Compact, lightweight pond vacuum cleaner. A fast and efficient way to clean the pond and dispose of waste.

- 60 Watt pump power.
- 3,000 L/h pump capacity.
- Stem length 2 metres.
- 2 suction mouths.

[Art. E6090100]



SuperFish Anti Ice Device

Make sure that your pond doesn't completely freeze over with the ice-free set with built in aeration.

Install the anti ice device before the freezing weather starts, will ensure that a hole is kept in the surface. This will ensure that fresh oxygen can enter the water while harmful gases can escape.

[Art. E6090545]



KoiPro Heater

Professional Heater complete with thermostat, for heating pond water or fish systems. Made from stainless steel and practically indestructible when properly installed.

To keep your pond healthy during the winter, we recommend maintaining a water temperature of at least 8 °C. This prevents the pond from freezing over and allows your fish to still receive a bit of food during their winter rest. In addition, the filter can continue operating through the winter if it is suitably insulated.

[Art. E6070100 Koi Pro Pond Heater 1 kW]

[Art. E6070105 Koi Pro Pond Heater 2 kW]

[Art. E6070110 Koi Pro Pond Heater 3 kW]



www.aquadistri.com

This is a publication of:

